

Builder Series

WWW.BUILDERSERIES.COM



FEATURES

Model #	LSS-300
Description	DOUBLE BOWL KITCHEN SINK
Material	304 STAINLESS STEEL
Color	STAINLESS STEEL
Mounting options	UNDER-MOUNT
Finish	SATIN BRUSHED
Thickness	18 GAUGE
Sound proofing	SPRAY AND SOUND PAD SYSTEM
Warranty	LIMITED LIFETIME
Overflow	NO
Drain size	3 5/8", STANDARD USA, CA AND EUROPE SIZE
Certifications	CAN/CSA-B45/ANSI-A112.19/ANSI-Z124/MASS
Fits cabinet size	MADE FOR CABINETS 33" AND LARGER

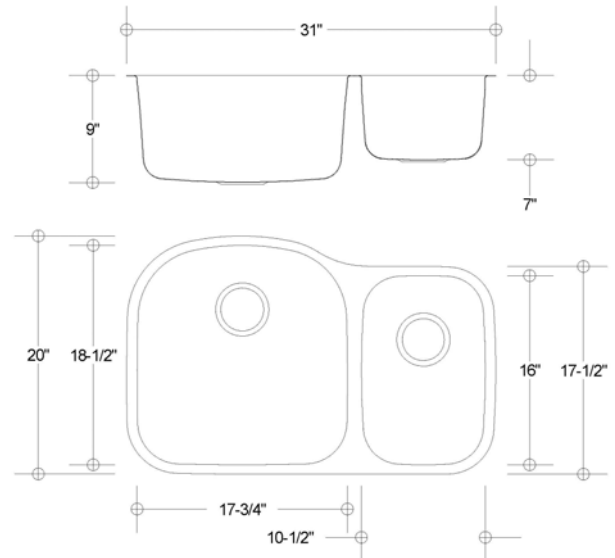

OPTIONAL ACCESSORIES:

The following accessories are available for your sink,



RESOURCES:

Installation instructions	www.specs.ctechi.com/sinkinstall.pdf
Cleaning instructions	www.specs.ctechi.com/cleaning.pdf
Warranty information	www.specs.ctechi.com/warranty.pdf
DXF file	www.specs.ctechi.com/LSS-300.dxf

For your protection and to insure the highest quality and standards, all C-TECH-I products meet or exceed one or more of the regulatory certification marks for the USA, Canada and Europe.

